

E014MWR840ELACB | KEPLERO 280 Fixed

Fixed recessed professional projector equipped with LED sources

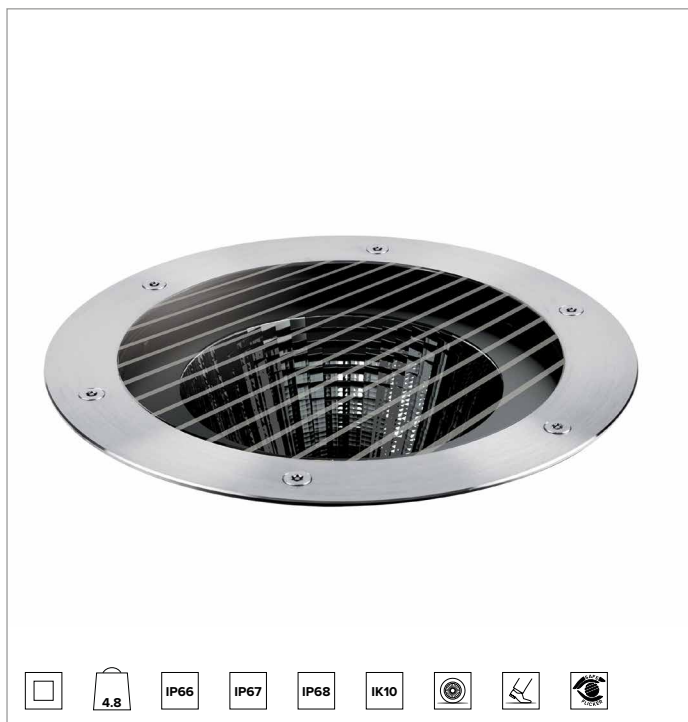

	4000K	H(m)	D(m)	Emax(lx)
	Ra80			51°
Fixture Power	34W	1	0.96	6445
Source Flux	5064lm	2	1.91	1611
Fixture Flux	4244lm	3	2.87	716
Efficacy	124lm/W	4	3.82	403
TS1853	Imax=1273cd/klm	Imax	6445cd	5
			4.78	258

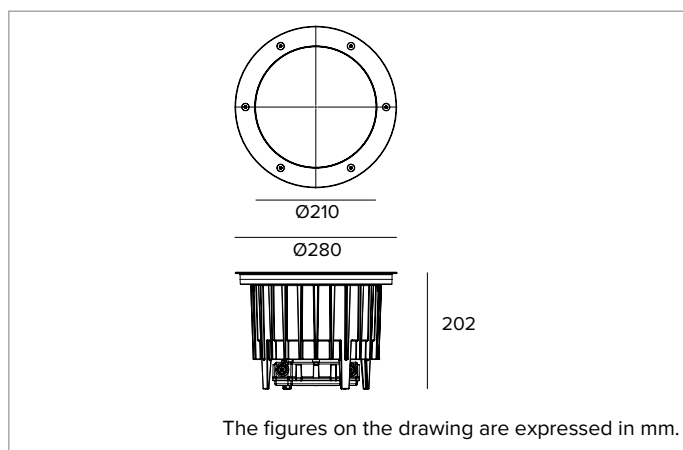

SOURCE

High efficiency Chip on Board LED Ra80. 3500K colour temperature available on request.

Energy efficiency class: D

Nominal power: 30W

Nominal flux: 5064lm

Colour rendering index: 80

Rf: 82

Rg: 95

CCT nominal: 4000K

Lifetime (L80/B10): >50000h tq +25°C

ILLUMINOTECHNICAL CHARACTERISTICS

Fixed reflector optic in faceted reflective anodised aluminium. Designed for the installation of multiple optical accessories to be ordered separately.

Optic: REFLECTOR

Beam angles: WFL

Optical efficiency: 84%

Fixture flux: 4244lm

Luminous efficacy: 124lm/W

Photobiological safety: Compliant with RG1 low risk group

MECHANICAL CHARACTERISTICS

Die-cast aluminium body with 3 layers of protection: anodised, cataphoresis and black paint. Brushed stainless steel (AISI 316) ultra flat decorative ring with bevelled edge (copper bronze finish). Version with anti-slip protective glass for public pedestrian areas. Anti theft stainless steel A4 Torx screws.

Colour and finish: Copper bronze

Weight: 4.8Kg

Version: ANTI-SLIP GLASS

Degree of protection: IP66,IP67,IP68

Mechanical Resistance: IK10

ELECTRICAL CHARACTERISTICS

Integrated IP68 ON-OFF electronic power supply equipped with IP68 waterproof connectors set for connection to the mains with a HO7RN8-F (max2x2.5mm²) cable. Fixture with a pass-through line.

Fixture Power: 34W

Power supply: 220-240Vac 50/60Hz

Insulation Class: CLASS 2

Type of driver / Control: ON-OFF

Driver included: YES

Class F: YES

SAFE FLICKER: PstLM=<1 and SVM=<0.4 (IEC TR 61547-1 and IEC TR 63158), to ensure a more comfortable and safe light

Ambient temperature: -25°C / +35°C

INSTALLATION

Nylon installation sleeve to be ordered separately as an accessory. The sleeve is pre-set for both flush or straight edge installation. 20kN resistance to static load.

NOTES

All light fixtures must be completed with an installation sleeve. IP68: the projector is not suitable for permanent underwater installation but can withstand temporary accidental immersion to a depth of 2 metres (max.24h). All versions of the KEPLERO family meet all the requirements of EN 60598-2-13 standard regarding drive-over and walk-over performances. Low temperatures on the glass make them suitable even for installation in "special areas", such as spaces for children. Uses the "Waterblock Plus" technical solution that involves resin coating the connection cables and completely resin coating the integrated driver limiting the risk of humidity reaching the fixture. 110-277Vac version available on request.

WARNING

Luminaire designed for disposal/recycling at end-of-life. Replaceable (LED only) light source by a professional. Replaceable control gear by a professional.

Due to the technological evolution of the electronic components, the data provided may be updated, and as such, confirmation must be requested during the order process.

Luminous flux and power supply have +/-10% tolerances with respect to the indicated value. tq +25°C (CIE 121).

We reserve the right to make technical changes.

Targetti Sankey S.r.l.
Via Pratese, 164
50145 Firenze - Italy
Tel: +39 055 37911
targetti.com
targetti@targetti.com

CCIAA Firenze
Share Capital:
€ 500.000,00
VAT N. (IT):
01537660480
R.E.A.: FI-275656

TARGETTI

E014MWR840ELACB | KEPLERO 280 Fixed

Fixed recessed professional projector equipped with LED sources

Related codes

Sleeve



Code

1E2394

Grey nylon installation sleeve.
The sleeve is pre-set for both flush or straight edge installation.
Complete with dedicated cover cap for installations in concrete.
Flush ring Ø 286 H.225.
Straight edge ring Ø 271 H. 223.

Accessories

Grid

Code

A060

Anti-glare louver.
Black painted metal honeycomb structure.
The louver is complete with a filter holder ring.

Filter

Code

A061

Flat striped glass blade light refractive filter.
This makes the beam take on an oval shape and when combined with spotlights, the light blade appears more prominent.
The accessory is complete with a filter holder ring.

Tool



Code

1E2496

Metal handle for fixture removal



Code

1E2495

Features TORX HEAD, TX 30.



Code

1E0388

Sucker tool to raise the glass.

Connector



Code

1E2769

Linear connection box IP66/IP68.
5 poles max. wire section 1.5mm².
Cable diameter range from 7 to 12mm.



Code

1E2494

Multiple connection box IP68.
1 IN - 3 OUT 4 poles max. wire section 2.5mm².
Cable diameter range from 6 to 12mm.

Due to the technological evolution of the electronic components, the data provided may be updated, and as such, confirmation must be requested during the order process.
Luminous flux and power supply have +/-10% tolerances with respect to the indicated value. tq +25°C (CIE 121).

We reserve the right to make technical changes.

Targetti Sankey S.r.l.
Via Pratese, 164
50145 Firenze - Italy
Tel: +39 055 37911
targetti.com
targetti@targetti.com

CCIAA Firenze
Share Capital:
€ 500.000,00
VAT N. (IT):
01537660480
R.E.A: FI-275656

TARGETTI

E014MWR840ELACB | KEPLERO 280 Fixed

Fixed recessed professional projector equipped with LED sources

Surge protector



Code

A013B

Surge protector compatible with CLASS II lighting fixtures and electronic drivers.

Operating voltage 220-240Vac.

SPD type 2+3.

Max surge protection 10kV.

CLASS II

IP67

Due to the technological evolution of the electronic components, the data provided may be updated, and as such, confirmation must be requested during the order process.

Luminous flux and power supply have +/-10% tolerances with respect to the indicated value. tq +25°C (CIE 121).

We reserve the right to make technical changes.

Targetti Sankey S.r.l.
Via Pratese, 164
50145 Firenze - Italy
Tel: +39 055 37911
targetti.com
targetti@targetti.com

CCIAA Firenze
Share Capital:
€ 500.000,00
VAT N. (IT):
01537660480
R.E.A: FI-275656

TARGETTI